

i-PRO

WV-S65340-Z4N WV-S65340-Z4K

S series PTZ camera with AI

2MP (1080p) 40x Outdoor PTZ Network Camera

S series models come standard with AI automatic tracking. It can automatically detect, zoom, and track intruders in a wide area, thereby supporting surveillance operators in many scenes. It also achieves the industry's highest level of drive durability to withstand high-speed and high-frequency camera movement by the automatic monitoring function.

AI monitoring camera, standard with AI Auto-tracking

- AI analysis functionality is standard on the camera side to promote automated surveillance. Accurately detects people and vehicles and automatically zooms in on intruders. Support surveillance operators to ensure that no tracked object is missed.
- Additional applications can be installed (up to two applications) to expand analysis functions such as AI privacy guard, person/vehicle attribute detection, etc.

Highly durable pan-tilt drive unit Reduced maintenance costs

- High durability gear drive achieves PAN and TILT drive durability (3.7 million movements). Low failure rate even with high frequency drive by automatic tracking function and reduced maintenance cost by minimizing the maintenance cycle.

Easy installation

- S-series compact PTZ cameras can be installed discreetly and easily on low ceilings.
- Easy kitting packaging allows the camera to be set up without removing it from the box during kitting prior to installation.
- The addition of a diverse lineup of mounting brackets and optional PoE injectors enables flexible installation regardless of the location of new or existing installations.

High security standard

- Highest level of security. In addition to digital certificates issued by a third-party organization (GlobalSign®), FIPS 140-2 level3-certified hardware is installed.

Key i-PRO Spec.

- 2MP (1080p) 1920x1080
- 40x optical zoom
- Intelligent Auto (with AI Engine)
- Super Dynamic 144dB
- Color night vision (0.001 to 0.015 lx)
- Durable Pan/Tilt gear mechanism
- ClearSight Coating
- IP66, IP67, IK10 certified
- ONVIF® Profile G / M / S / T *ONVIF is a trademark of ONVIF, Inc.
- FIPS 140-2 level3 certified
- -Z4K model : Heavy-duty salt damage-resistant coating

Industry examples

- Safe Cities
- Transportation (Airport / Train, Subway station)
- Stadium
- Critical infrastructure



Specifications

Camera	Image Sensor	Approx. 1/2.8 type CMOS image sensor
	Minimum Illumination	Color : 0.015 lx (50IRE, F1.6, 1/30s) Color : 0.001 lx (50IRE, F1.6, 16/30s)*1 BW : 0.006 lx (50IRE, F1.6, 1/30s) BW : 0.0004 lx (50IRE, F1.6, 16/30s)
	White Balance	ATW1 / ATW2 / AWC
	Shutter Speed	[60 fps Mode] 1/60 Fix to 1/10000 Fix, [30 fps/15 fps mode] 1/30 Fix to 1/10000 Fix [50 fps Mode] 1/50 Fix to 1/10000 Fix, [25 fps/12.5 fps mode] 1/25 Fix to 1/10000 Fix
	Intelligent Auto	On / Off
	Super Dynamic*2	On / Off. The level can be set in the range of 0 to 31.
	Dynamic Range	Max.144 dB (Super Dynamic : On, Level 31)
	Adaptive Black Stretch	The level can be set in the range of 0 to 255.
	Back light compensation / High light compensation	BLC (Back light compensation) / HLC (High light compensation) / Off The level can be set in the range of 0 to 31 (only when Super dynamic / Intelligent Auto : Off)
	Fog compensation	On / Off. The level can be set in the range of 0 to 8 (only when Intelligent auto / auto contrast adjust : Off)
	Maximum gain (AGC)	The level can be set in the range of 0 to 11.
	Color/BW (ICR)	Off / On / Auto1 / Auto2 / Auto3 (SCC)
	Digital Noise Reduction	The level can be set in the range of 0 to 255.
	Video Motion Detection (VMD)	On / Off, 4 areas available
	Scene Change Detection (SCD)	On / Off, 1 areas available
	Audio Detection	On / Off
	AI Sound Classification	Gunshot, Yell, Vehicle horn, Glass break
	AI Analytics	Yes
	Privacy Zone	On / Off, Up to 32 zones available
	VIQS	On / Off, Up to 8 zones available
Image Stabilizer	On / Off	
Camera Title (OSD)	On / Off, Up to 40 characters (alphanumeric characters, marks)	
Focus Adjustment	Auto focus	
Lens	Optical zoom	40x (Motorized zoom / Motorized Focus)
	Extra zoom	Max. 60x (40 to 60x : When resolution is 1280 x 720)
	Focal length	4.25 - 170 mm {11/64 inches - 6-11/16 inches}
	Angular Field of View	[16 : 9 mode] Horizontal : 2.1° (TELE) - 65° (WIDE), Vertical : 1.2° (TELE) - 39° (WIDE) [4 : 3 mode] Horizontal : 1.6° (TELE) - 51° (WIDE), Vertical : 1.2° (TELE) - 39° (WIDE)
Maximum Aperture Ratio	1 : 1.6 (WIDE) - 1 : 4.95 (TELE)	
Focus range	3 m {118-7/64 inches} - ∞	
DORI	Detect (25ppm / 8ppf)	Wide: 60.3 m / 197.8 ft, Tele: 2095.2 m / 6873.9 ft
	Observe (62.5ppm / 19ppf)	Wide: 24.1 m / 79.1 ft, Tele: 838.1 m / 2749.5 ft
	Recognize (125ppm / 38ppf)	Wide: 12.1 m / 39.6 ft, Tele: 419.0 m / 1374.8 ft
	Identify (250ppm / 76ppf)	Wide: 6.0 m / 19.8 ft, Tele: 209.5 m / 687.4 ft
System on Chip (SoC)		Ambarella CV25M
Adjusting Angle		Horizontal : 360° Endless Panning, Vertical : -15° to +195°, Yaw : 0°
Pan/Tilt	Panning Range	360° Endless Panning
	Panning Speed	Manual: Approx. 0.065°/s - 150°/s Preset: Up to approx. 500°/s
	Tilting Range	Operational -15 - +195°
	Tilting Speed	Manual: Approx. 0.065°/s - 150°/s Preset: Up to approx. 500°/s
	Preset Positions	256 positions
	Auto Mode	Auto track/ Auto pan/ Preset sequence/ Patrol
Self Return	10 s / 20 s / 30 s / 1min / 2 min / 3min / 5 min / 10 min / 20 min / 30 min / 60 min	
Browser GUI	Camera Control	Brightness, AUX On / Off
	Audio	Mic (Line) Input : On / Off Volume adjustment : Low / Middle / High Audio Output : On / Off Volume adjustment : Low / Middle / High
	GUI / Setup Menu Language	English, Italian, French, German, Spanish, Portuguese, Russian, Chinese, Japanese
Browser*3	Microsoft Edge, Firefox, Google Chrome	
Network	Network IF	10Base-T / 100Base-TX, RJ45 connector
	Resolution	[16 : 9 mode (60 fps mode)]*2 , [16 : 9 mode (30 fps mode)] , [16 : 9 mode (50 fps mode)]*2 , [16 : 9 mode (25 fps mode)] 1920x1080, 1280x720, 640x360, 320x180 [4 : 3 mode (30 fps mode)] , [4 : 3 mode (25 fps mode)] 1280x960, VGA, QVGA [4 : 3 mode (15 fps mode)] , [4 : 3 mode (12.5 fps mode)] 2048x1536*4, 1280x960, VGA, QVGA
	H.265 / H.264*5	Transmission Mode
	JPEG	Transmission Type
	JPEG	Image Quality

Network	Smart Coding	GOP (Group of pictures) control: Off / Low (Variable GOP 1s-8s) / Mid (Variable GOP 4s-16s) / Advanced(Fixed GOP 60s w/1s key-frame) / Frame rate control (Variable GOP 4s-16s with frame rate control) *Advanced and Frame rate control are only available with H.265. Smart VIQS: On(High) / On(Low) / Off. Smart P-picture control: On / Off
	Audio Compression	G.726 (ADPCM) : 16 kbps / 32 kbps G.711 : 64 kbps AAC-LC*6 : 64 kbps / 96 kbps / 128 kbps
	Audio transmission mode	Off / Mic (Line) input / Audio output / Interactive (Half duplex) / Interactive (Full duplex)
	Supported Protocol	IPv6 : TCP/IP, UDP/IP, HTTP, HTTPS, SSL/TLS, SMTP, DNS, NTP, SNMPv1/v2/v3, DHCPv6, RTP, MLD, ICMP, ARP, IEEE 802.1X, DiffServ IPv4 : TCP/IP, UDP/IP, HTTP, HTTPS, SSL/TLS, RTSP, RTP, RTSP/RTCP, SMTP, DHCP, DNS, DDNS, NTP, SNMPv1/v2/v3, UPnP, IGMP, ICMP, ARP, IEEE 802.1X, DiffServ, SRTP, MQTT, NTCP
	No. of Simultaneous Users	Up to 14 users (Depends on network conditions)
	Secure	FIPS 140-2 level3, Device Certificate GlobalSign® pre-installed
	SDXC/SDHC/SD Memory Card	H.265 / H.264 recording : Manual REC / Alarm REC (Pre/Post) / Schedule REC / Backup upon network failure JPEG recording : Manual REC / Alarm REC (Pre/Post) / Backup upon network failure Compatible SDXC/SDHC/SD Memory Card : microSDXC memory card : 64 GB, 128 GB, 256 GB, 512 GB microSDHC memory card : 4 GB, 8 GB, 16 GB, 32 GB microSD memory card : 2 GB
	Mobile Terminal Compatibility	iPad, iPhone (iOS 8.0 or later), Android™ terminals
	ONVIF® Profile	G / M / S / T
	Alarm	Alarm Source
Alarm Actions		SDXC/SDHC/SD memory recording, E-mail notification, HTTP alarm notification Indication on browser, TCP alarm notification output
Input/ Output	Audio input	Ø3.5 mm stereo mini jack
	For microphone input :	Recommended applicable microphone : Plug-in power type (Sensitivity of microphone : -51 dB to -38 dB (0 dB=1V/Pa, 1 kHz)) Input impedance : Approx. 2 kΩ (unbalanced) Supply voltage : 2.5 V ±0.5 V Input level : Approx. -10 dBV
Audio Output	Ø3.5 mm stereo mini jack (monaural output) Output impedance : Approx. 600 Ω (unbalanced) Output level : -20 dBV	
External I/O Terminals	ALARM IN 1 (Alarm input 1/ Black & white input/ Auto time adjustment input) (x1) ALARM IN 2 (Alarm input 2/ ALARM OUT) (x1), ALARM IN 3 (Alarm input 3/ AUX OUT) (x1)	
General	Safety	UL (UL62368-1), c-UL (CSA C22.2 No.62368-1), CE, IEC62368-1
	EMC	FCC (Part15 ClassA), ICES-003 Issue 7 ClassA, EN55032 ClassA, EN55035
	Power Source and Power Consumption	AC24 V, PoE++ (IEEE802.3bt), PoE+ (IEEE802.3at) AC24 V, 3.4 A Approx. 53.3 W PoE++ DC 54 V 940 mA, Approx. 50.84 W(Class6 device) PoE+ DC 54 V 470 mA, Approx. 25.4 W(Class4 device)
	Ambient Operating Temperature	-50 °C to +60 °C (-58 °F to +140 °F) (AC24V, PoE++) -30 °C to +60 °C (-22 °F to +140 °F) (PoE+ device) (Power On range : -30 °C to +60 °C (-22 °F to +140 °F)) Maximum temperature according to NEMA TS2(2.2.7) : 74 °C(165 °F)
	Ambient Operating Humidity	10 to 100 % (no condensation)
	Anti-Condensation System	Temish element + Heater + FAN + ROSAHL
	Water and Dust Resistance	IP66, IP67, IEC60529 measuring standard compatible, Type 4X(UL50E), NEMA 4X compliant
	Shock Resistance	IK10 (IEC 62262)
	Other standard support	NEMA TS2(2.2.7-2.2.9)
	Dimensions	Ø229 mm x 278 mm (H) {Ø9-1/32 inches x 10-15/16 inches (H)}
Mass (approx.)	Approx. 4.3 kg {9.48 lbs.}	
Finish	Main body : Aluminum die cast, i-PRO white (-Z4K model : Heavy-duty salt damage-resistant coating) Outer fixing screws : Stainless steel (Corrosion-resistant treatment) Dome section : Polycarbonate resin, Clear (with ClearSight coating)	

*1 Converted value

*2 When 60 fps or 50 fps is selected, the Super Dynamic function is automatically set to off.

*3 For information on the operation verification of the supported web browsers, refer to our support website <Control No.: C0132>.

*4 Used by super resolution techniques

*5 Transmission for 4 streams can be individually set.

*6 When recording audio on a microSD memory card, only use AAC-LC (Advanced Audio Coding - Low Complexity).

Appearance

Unit : mm (inches)

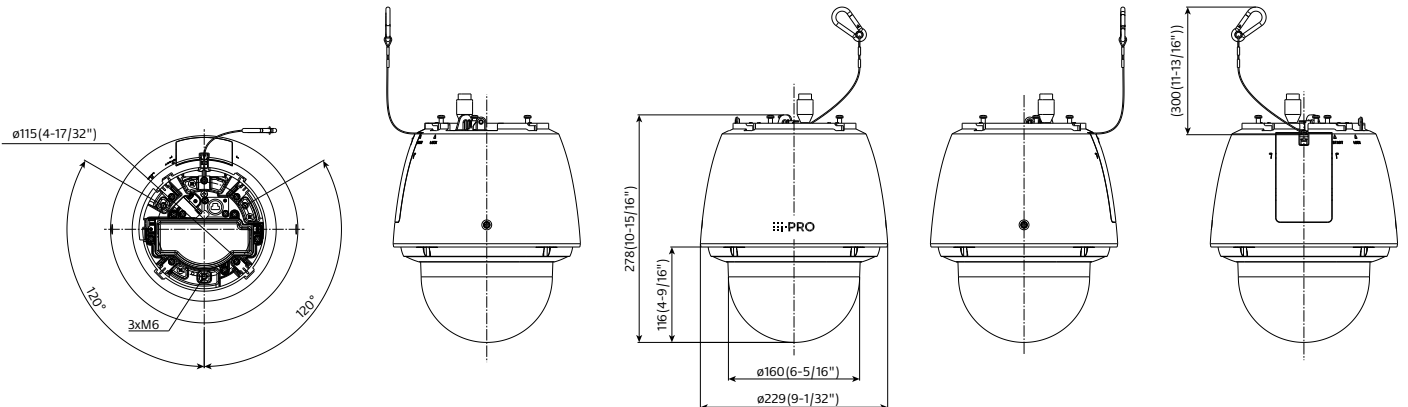

AI Analytics applications

<https://i-pro.com/global/en/surveillance/products/i-pro-ai-application>

AI Video Motion Detection (AI-VMD)

Advanced video analysis technology detects objects (faces, people, cars, motorcycles) in a specified area. (Intruder Detection, Loitering Detection, Direction Detection, Cross Line Detection)

AI Privacy Guard

To protect privacy and portrait rights, it is possible to automatically apply a mosaic the entire face and figure of a person photographed by the camera.

AI Face Detection

Detects faces with high precision even in low-light, backlit, and mask-wearing environments.

AI People Detection

Extract the characteristics of human face / clothing and classify them into meaningful categories such as gender, age, and clothing color.

AI Vehicle Detection

Extract vehicle characteristics and classify them into meaningful categories such as type and color.

AI Non mask Detection

Deep-learning and proprietary image processing technologies recognize mask and detect people who are not wearing them.

AI Occupancy Detection













Detecting the congestion via network camera with AI engine enables that information to be used direct visitors in advance or help store staff work more efficiently.

3rd party applications are also available.

<https://i-pro.com/global/en/surveillance/i-pro-application-platform/application-list>

Optional Accessories

Mount Bracket / Other

	WALL	POLE	CORNER	HANGING	CEILING	OTHER
	1	1	1	1	1	1
	Wall Mount Bracket WV-QWL501-W WV-QWL501S-W (White) 	Pole Mount Bracket PAPM4W (White) 	Corner Mount Bracket PACA4W (White) 	Ceiling Mount Bracket WV-QCL501-W WV-QCL501S-W (White) 	Ceiling surface mount bracket WV-QCL500-W (White) 	3rd Party Pipe (Male or Female type)
combination	Mount Bracket WV-QSR504-W WV-QSR504S-W (White) 	Wall Mount Bracket WV-QWL501-W WV-QWL501S-W (White) 	Wall Mount Bracket WV-QWL501-W WV-QWL501S-W (White) 	Mount Bracket WV-QSR504-W WV-QSR504S-W (White) 		Mount Bracket WV-QSR504F1-W (White, ANSI Female thread) WV-QSR504M1-W (White, ANSI Male thread)  
		Mount Bracket WV-QSR504-W WV-QSR504S-W (White) 	Mount Bracket WV-QSR504-W WV-QSR504S-W (White) 			

*WV-QSR504S-W, WV-QWL501S-W and WV-QCL500S-W are heavy-duty salt damage-resistant coating accessories.

Dome Cover

Dome Cover (Smoke type)
WV-QDC503G



Trademarks and registered trademarks

- GlobalSign and the GlobalSign Logo are registered trademarks of GMO GlobalSign K.K.
- iPad and iPhone are trademarks of Apple Inc., registered in the U.S. and other countries.
- Android is a trademark of Google LLC.
- ONVIF is a trademark of ONVIF, Inc.
- All other trademarks identified herein are the property of their respective owners.

Important

- Safety Precautions : Carefully read the Basic Information, Installation Guide and Operating Instructions before using this product.
- i-PRO Co., Ltd. cannot be held responsible for the performance of the network and/or other manufacturers' products used on the network.

• Masses and dimensions are approximate. • Specifications are subject to change without notice.